

EN

SOUL³ USER MANUAL

Version 06-2024

FLYSURFER

CONTENT

01	Release of liability.....	4
02	Safety notes.....	5
02.01	Do not fly with kites.....	5
03	Overview of the kite.....	6
04	Handling.....	8
04.01	Setting up a foil kite.....	8
04.02	Sorting the bridle.....	9
04.03	Securing a foil kite.....	9
05	Launching.....	10
05.01	Self launching a foil kite at the edge of the wind window.....	10
05.02	Edge of the wind window with a helper on a foil kite.....	11
06	Relaunch.....	11
06.01	Reverse launch.....	11
06.02	One line relaunch.....	12
06.03	Drainage.....	13
07	Landing.....	13
07.01	Landing with an assistant.....	13
07.02	Self-landing by backstall.....	14
07.03	Self-landing using the Frontline Safety.....	14
08	Safety System.....	15
08.01	Reactivating the kite.....	15
09	Emergencies.....	15
09.01	Self-rescue with a foil kite.....	16
10	Packing up.....	17
11	Kite care.....	18
12	Maintenance.....	18
12.01	Replacing the sparepart lines and pulleys.....	18
12.02	Little Connection Lines.....	19
12.03	Repairing the cloth.....	19
13	Trimming.....	20
13.01	Mixer.....	20
13.02	Camber Trim System.....	20
13.03	Bridle-check.....	20
13.04	Profile Moment Adjuster (PMA's).....	22
13.05	Optimum trim of the flying lines.....	22
13.06	Performance Tuner.....	23
14	Repair & spare parts.....	23

01 RELEASE OF LIABILITY

Release of liability, claim waiver, assumption of risk

By assembling and/or using this FLYSURFER product, you agree that you have read and understood the entire FLYSURFER product manual, including all instructions and warnings contained in that user manual, prior to using the FLYSURFER product in any way. You additionally agree that you will ensure any additional or subsequent user of your FLYSURFER product will read and understand the entire FLYSURFER product user manual, including all instructions and warnings contained in that user manual, prior to allowing that person to use your FLYSURFER product.

Assumption of Risk

FLYSURFER product and any of its components involve certain risks, dangers, and hazards that can result in serious personal injury and death to both the user and to non-user third parties. By using this FLYSURFER product, you freely agree to assume and accept any and all known and unknown risks of injury to yourself and third parties while using this equipment. The risks inherent in this sport can be greatly reduced by abiding by the warning guidelines listed in this user manual and by using common sense.

Claim Waiver

Release and waiver of claims in consideration of the sale of the FLYSURFER product to you, you hereby agree to the fullest extent permitted by law, as follows:

To waive any and all claims, that you have or may in the future have against Skywalk GmbH & Co. KG and all related parties resulting from use of the FLYSURFER Product and any of its components. To release Skywalk GmbH & Co. KG and all related parties from any and all liability for any loss, damage, injury or expense that you or any users of your FLYSURFER product may suffer, or that your next of kin may suffer, as a result of the use of the FLYSURFER product, due to any cause whatsoever, including negligence or breach of contract on the part of Skywalk GmbH & Co. KG and all related parties in the design or manufacture of the FLYSURFER product and any of its components. In the event of your death or incapacity, all provisions contained herein shall be effective and binding upon your heirs, next of kin, executors, administrators, assigns, and representatives. Skywalk GmbH & Co. KG-related parties have not made and expressly deny any oral or written representations other than what is set forth herein and the FLYSURFER User's Manual.

If you have any questions (repair, replacement parts installation, tuning, etc.) the dealers you trust can provide faster help and correspondingly cheaper support (e.g. by saving shipping costs).

You can find all dealers in your area via our partner map:

<https://flysurfer.com/fs-partner/>

If you need further help, you can reach us at headquarters by phone or email.

E-Mail: support@flysurfer.com

Phone: +49 (0) 8641 6948 0

02 SAFETY NOTES

Read the entire user manual thoroughly before using the product, and strictly conform to the procedures noted. **The following safety guidelines are only guidelines and do not claim to cover every instance.**

01. Kitesurfing is a **potentially dangerous sport**, that holds risks for the athlete or the people surrounding them. Incorrect use of this product may result in **serious injury or even death** for the user or third parties. Every user should be qualified by a FLYSURFER kiteschool or a FLYSURFER dealer.
02. The user carries the **sole responsibility** for themselves and third parties when using this product. The user must check their equipment for wear, especially wearing parts, before each kite session. Do a test activation of your quick release before every launch. This will ensure the system is working and reinforces the release instinct of the kiter.
03. The product may **only be used with original spare parts**, and may not be modified.
04. This product has been designed for riders weighing 40-120kg. We cannot guarantee the proper functioning of the product outside of this weight range.
05. Never kite in unsuitable conditions such as storm fronts, lightning, or offshore winds. Check the weather and wind conditions carefully and choose the appropriate kite size.
06. Check out the kiting spot beforehand. Make sure you are aware of any risks and dangers such as obstacles, shallows, currents and bans. Also, be aware if a rescue craft can get to you in case of an emergency. It is always best to ask people (locals) who know the area well.
07. Keep a safety margin of at least two line-lengths downwind of you, and never kite near people or obstacles. Kiting near powerlines, roads, airports, cliffs, etc, is extremely dangerous.
08. Make sure that someone is looking out for you and that help is there if you need it. Never go out alone. Never kite further away from shore than you can swim back.
09. The incorrect usage of lines creates a high risk of injury for yourself and others. Body parts that get caught in the lines of the kite may suffer from severe injury or burns.
10. Only use bars with a safety system that you can open in emergency situations. Use a quick-release kite leash so that you can disconnect your body from the product in case of an unforeseeable emergency.

02.01 Do not fly with kites

A kite is not designed, tested or licensed as an aircraft or flying device. The use of a kite as a flying device is illegal and not covered by insurance. **Flying** with this product **can lead to death!**

03 OVERVIEW OF THE KITE



1 Streamlined Lightweight Construction

Constructed from state-of-the-art, lightweight materials to obtain an optimal power-to-weight ratio. The high-strength sail is a triple-ripstop 34 g/m² TX-Light, and the leading edge features a very durable 44 g/m² DLX+ fabric that protects against abrasion. All SOUL components are designed for maximum performance on any terrain. The integrated automatic drainage system is hidden in the construction. Dirt, water, and small objects inside the kite slide automatically from the kite's center to the wing tips. They exit through two openings at the trailing edge of the wingtips. The streamlined construction ensures that the kite remains agile and highly maneuverable while maintaining peak performance.

2 Bridle Check Tool

The bridle check tool simplifies the comparison of bridle line lengths. On each wing side of the foil kite, at every level (A, B, C, Z), black markings facilitate easy comparison of front and back main line lengths (refer to the line plan). Adjust the length between B and C levels relative to the A level to maintain optimal flight characteristics by moving the rings on the mixer. We advise regular checks using the bridle check tool for consistent performance and stability, especially with frequent product use.

3 Reflex Profile

The reflex profile keeps the foil kite stable at a low angle of attack and at full acceleration. The counter-arching pushes the trailing edge down and prevents a front stall. The reflex profile is essential for controlling and depowering a foil kite.

4 High-Tensile Strength Bridle Line Configuration

The bridle line configuration is crucial in managing stability, performance, and ease of control. A well-designed bridle system balances the forces exerted on the structure and precisely controls its behavior. We use Dyneema for the A-line and brake and Kevlar lines for the B and C-lines. The lines are coated with a UV-resistant layer to prevent degradation due to UV exposure. This protective coating extends the lines' lifespan and reduces wear and tear from sun exposure. These materials ensure that the lines maintain their length and strength over time, reducing the need for frequent adjustments or replacements.

5 Deflation Velcro Fastener Valve

We rely on deflation valves with velcro fasteners. They are in the middle of the trailing edge of our foil kites. Our freeride products have additional loops sewn on the Deflation Velcro Fastener Valve for opening them more easily with gloves. Warning prints are attached to the pull-out cloth sections; you can visually check the valve is closed.

6 Profile Momentum Adjuster

The PMAs are knot ladders sewn onto the profile inside the foil kite. They sit on the upper and lower sails between the A and B levels. Shortening the knot ladders can adjust the profile camber, giving the foil kite more performance or stability. If a change is made, it should be made symmetrically. We recommend the help of a FLYSURFER sales partner to ensure the profile momentum adjuster is set to the correct settings.

7 Automatic Drainage System

The Automatic Drainage System hides in the internal construction of our closed-cell foil kites. Dirt, water and small objects that got inside the kite slide automatically from the middle section to the wingtips. They exit the kite through two big holes at the trailing edge of the wingtips.

8 Air intake Crossline

Lines have been stretched across all air inlets to ensure optimal airflow to the leading edge. The air inlet cross lines hold the rigid foils on the nose in position and prevent the inlets from deforming. The kite fills quickly with air. You get control over the entire wingspan sooner when launching the foil kite. The kite also flies further to the edge of the wind window when overpowered; the leading edge dents later, and the depower works more efficiently.

04 HANDLING



A kite needs to be secured properly even if the wind is light. A runaway kite can be a serious danger to people or animals downwind. To ensure a long lifespan of your kite, we recommend that you do not leave the kite flapping in the wind and sun for long periods

04.01 Setting Up a foil kite

1 Lay the kite out on a surface free of hard or sharp objects. Unroll your kite upside down into the wind and secure it with something that has no sharp edges and is heavy enough to hold down the kite for the given wind. Place the bar far enough away from all bridle lines on the trailing edge side of the kite. Ensure that the bar cannot fall or be pulled into the bridles.

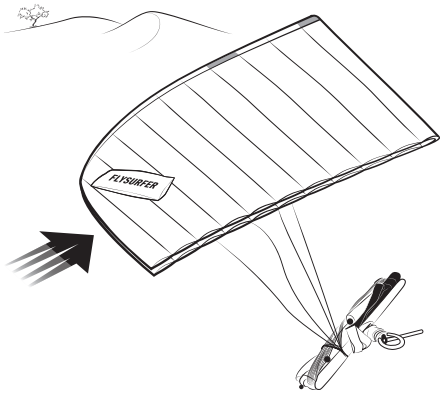

2 Open the kite and if necessary, close the deflate valves. Unroll the lines from your bar whilst walking away from the kite.

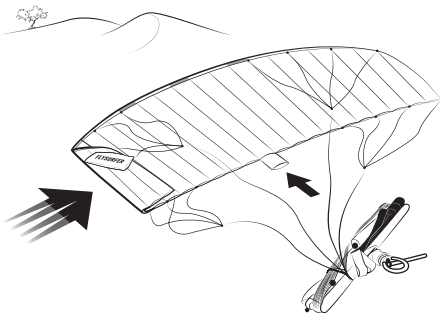

3 Check your bridle for tangles. Make sure that none of the lines are caught around the back of the kite.

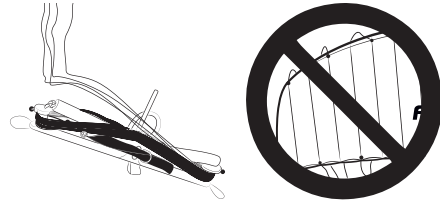

4 Start at the leading edge holding up the front lines to visually check the bridle step by step.

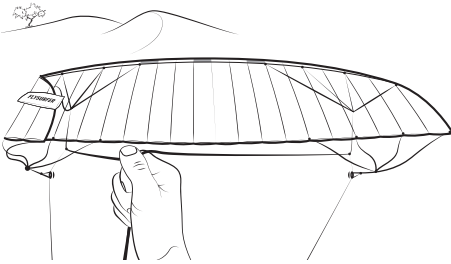

5 When the bridle is sorted out, lay the front lines to the inside and the steering lines to the outside. If not, follow the tips on the "Sorting out the bridle" chapter.

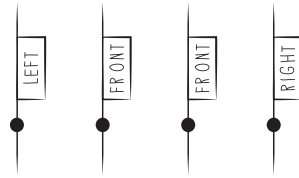

6 Ensure your flying lines are connected correctly and clear of any potential hazards. Check for any damage or knots.

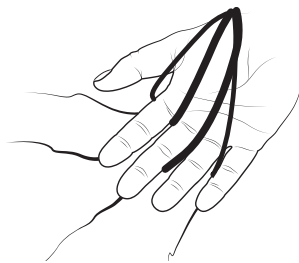

Exception: There is a "stopper" knot in one of the flying lines that prevents the bar from sliding up too far when released.

7 If the lines are still twisted, untwist them by turning the bar. It may be possible (especially after not being careful when packing away or setting up the kite) that the bar has to be pushed through the lines again to untwist.

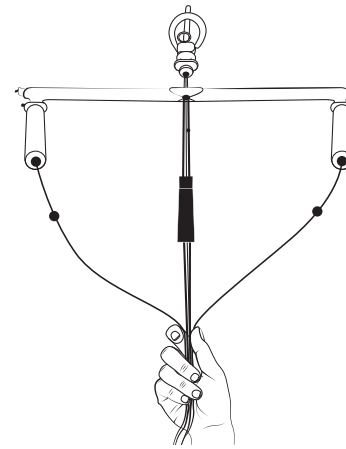

04.02 Sorting the bridle

Even a badly tangled bridle can be quickly sorted out with the right technique. If the bridle is tangled, it was probably caused by mistakes made when packing or setting up the kite.

1 Roll up your lines onto the bar until you get close to the mixer and secure the lines with a half hitch and/or the bungee cord.

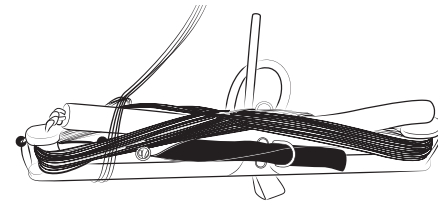

2 Undo any loops, knots or bunches that may have formed. If the bridle is tangled, lines from one side of the bridle may be running through the lines on the other side. Stick the bar along these lines through the bridle.



3 Lightly tension the bridle again to check it. If necessary, repeat the last step until the left and right bridles are separated.

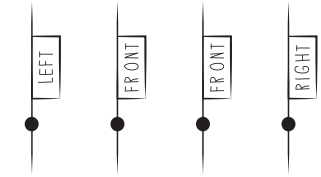

04.03 Securing a foil kite

1 Fold your kite in the middle and let the tips flow out downwind. The bottom sail and the bridle will be facing inwards. Weigh down the kite in the front third of the top sail. This method prevents the tips from flapping in the wind. Opening the deflate valve(s) can also help.

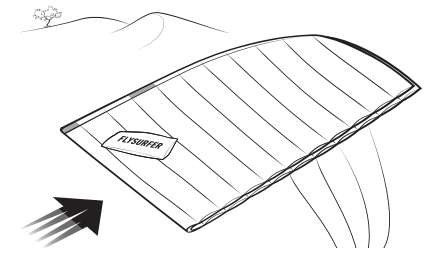

Tip: The kite can also be secured using the same method as the launch. However, it has been proven that the above method keeps the kite more still in higher winds.

2 Make sure that the tips are not flapping too much. This can lead to the bridle getting tangled. The tips can be additionally secured with a bit of sand or other suitable object.

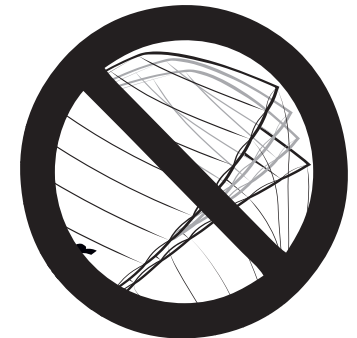

- 3 Open the deflate valves. A deflated kite will flap around on the ground less.

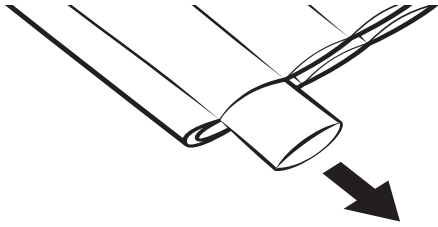

05 LAUNCHING

Please check not only the wind and weather conditions, but also all your equipment, especially the safety system before launching. Do not use any kite outside of its recommended upper wind range. When launching in strong winds, we recommend that you have an assistant holding you from the back of your harness. During launching, always pay attention that your bridle lines do not get caught on anything or become tangled.

05.01 Self launching a foil kite at the edge of the wind window

- 1 Lay the kite out 90° to the wind. Fold over the windward wingtip and secure it near the leading edge.

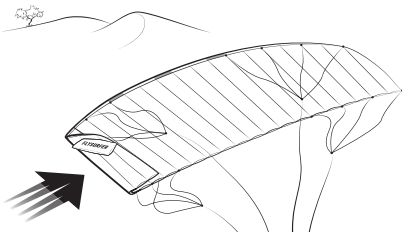

- 2 Pre-inflate the kite at least half way, for more control during the launch. The kite should be positioned 15-30° downwind of you when you slowly tension the lines for launch.

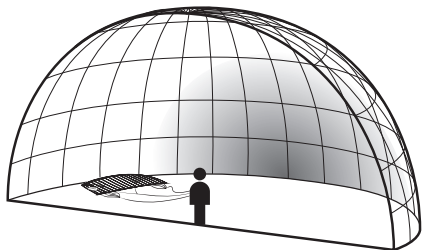

- 3 Walk downwind a bit as the kite inflates.

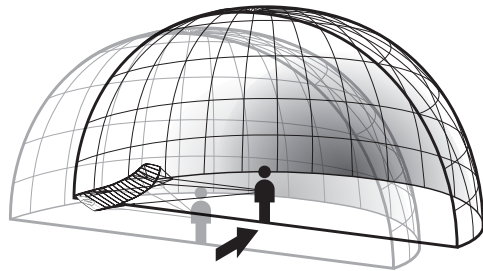

- 4 Pay attention that the downwind wingtip does not fold over upwind.



- 5 Release the kite from the sand or object securing it with a step backwards away from the kite and carefully steer it.

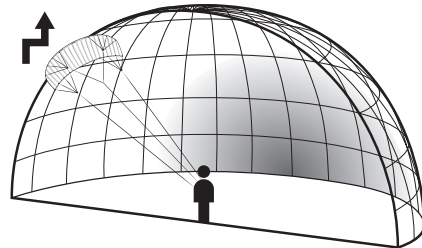

Tip: You can prevent the lines getting caught around the bottom wingtip by folding over the tip once more and securing the second fold with e.g. sand.

05.02 Edge of the wind window with a helper on a foil kite

It is important that your helper is experienced with this technique and you have explained them how it's done.

- 1 Position kite and helper exactly on the edge of the window.

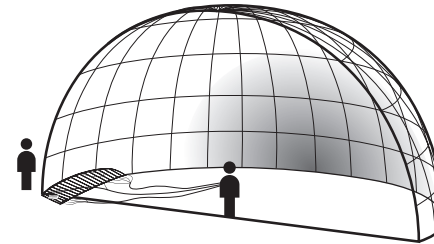

- 2 The helper begins from the center of the kite and holds multiple air intakes into the wind. As the kite fills, the helper slowly works his hands down the leading edge of the kite letting the inflated parts of the kite rise up. The bottom tip should not be touching the ground anymore.

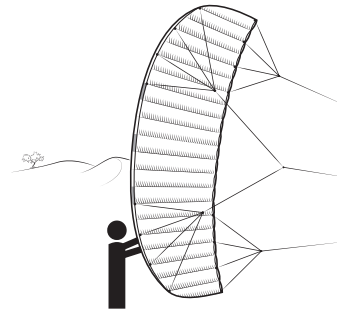

Tip: Pre-fill the kite properly!

- 3 As soon as the kite is inflated and you are ready, give the helper the thumbs up signal that they can let go. Make sure to once again check whether all lines run freely before doing this.

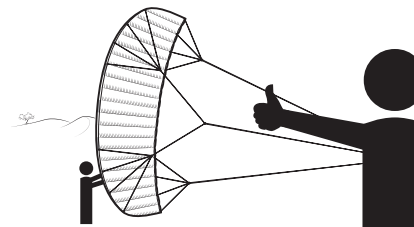

- 4 If the kite is threatening to collapse over the assistant, you can either walk downwind, or the assistant upwind.



Note: Get aligned with the wind, the helper retains his position and is not moving around.

06 RELAUNCH

06.01 Reverse Launch

- 1 Grab the leader lines above the floaters as high up as you can. Make sure that the bar is the right way up. Do not cross over your hands.

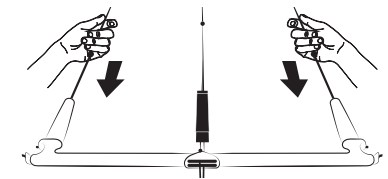

- 2 Pull in both leader lines as far towards yourself as possible to reverse the kite off the water. Strong pulls or pumping the lines may help in light winds. If the kite does not release from the water, grab the leader lines higher up.

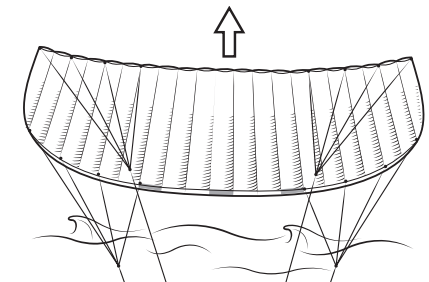

- 3 When the kite is at least one wingspan above the water, let go of one of the leader line. Make sure you keep hold of the other one and the bar is in the right position.

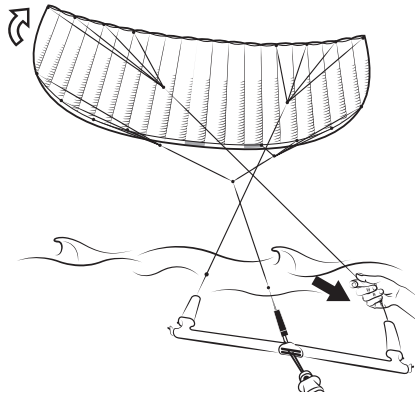

- 4 The kite will now spin around. As soon as the leading edge of the kite points up let go of the remaining leader line and put your hand back on the bar. Depower the kite till its back in the sky towards the zenith.

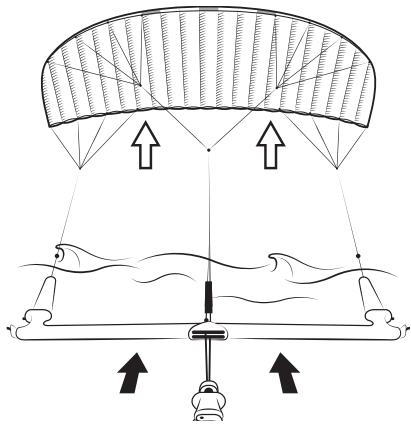

Tip: The reverse launch is the recommended relaunch method when kiting on solid terrain. This minimizes potential damage from abrasion.

06.02 One Line Relaunch

- 1 Grab one steering line high above the floater. Pull back the line far enough towards you so that the kite starts to peel to the side you are pulling. Keep pulling until the kite launches at the edge of the wind window.

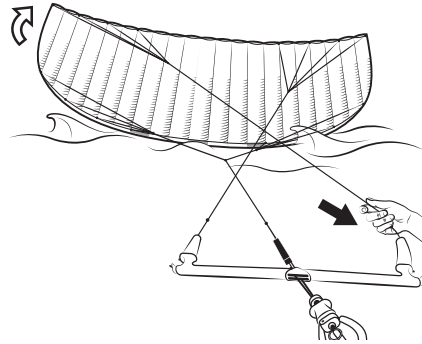

If the kite does not lift up and peel to one side when pulling the leader line, try pulling the opposite leader instead. If this still does not work, then use the reverse launch method.

- 2 Let go of the steering line as soon as the leading edge of the kite points up. Grab the bar and keep it depowered until the kite is flying again.

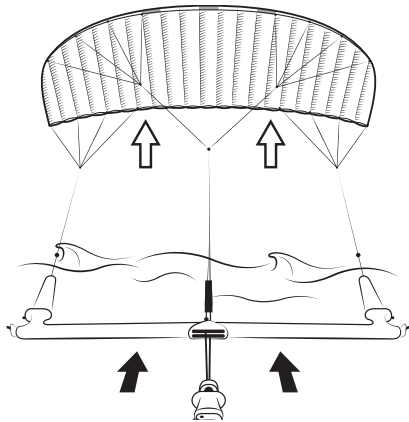

06.03 Drainage

- 1 The drainage system ensures that water or dirt are automatically removed from the kite. The kite has to be turned upright onto its side. Try to achieve this by pulling on one steering line. Try to prevent the upper wingtip from collapsing.

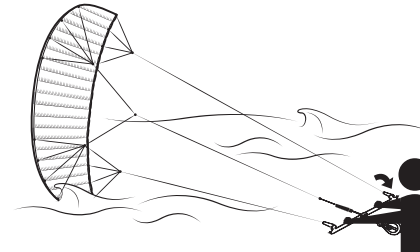

- 2 The excessive water/dirt should now flow out of the tip until it is ready to be launched again.

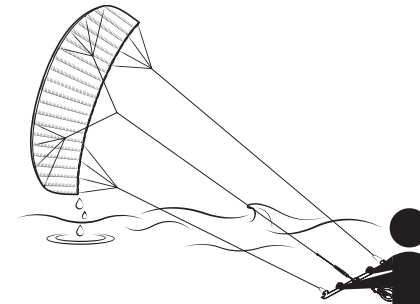

07 LANDING

07.01 Landing with an assistant

- 1 The easiest and safest way to land your kite is with the help of an assistant. Signal a helper who knows how to land your kite, that you want to land. The helper should be standing well upwind of the kite.

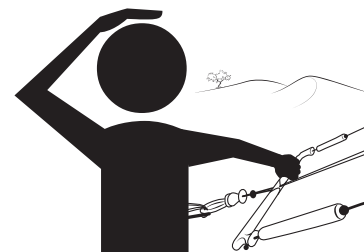

- 2 Lower the kite towards the helper along the edge of the wind window.

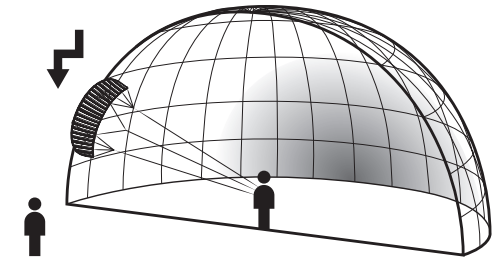

- 3 The helper can now approach the kite and grab hold of the leading edge of the kite.

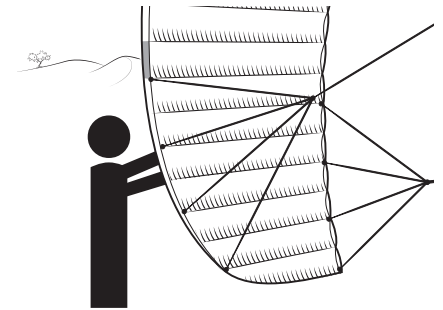

!!! Warning: The helper should never grab any lines.

- 4 As soon as the helper has the kite securely in their hands, walk towards them until all flying lines are no longer under tension. This way the kite will flag out downwind of the helper.

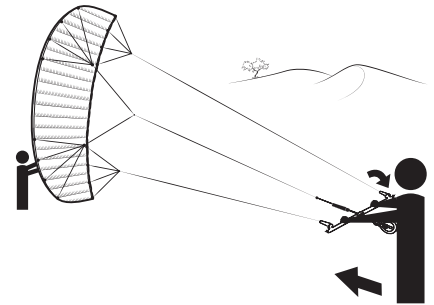

- 5 Secure the kite as described in "Securing the Kite".

07.02 Self-landing by backstall



Warning: Keep at least two line-lengths safety distance downwind. We generally recommend landing with the help of an assistant. Landing the kite by backstall should only be attempted in light winds.

- 1 Grab both leader lines above the floaters.

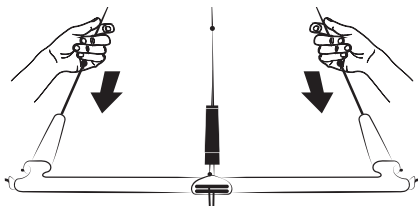

- 2 Pull them back towards you until the kite stalls and flies backwards towards the ground. To a certain degree you can still control the kite as it flies backwards. Never let go of the leader lines when attempting this self-landing procedure.

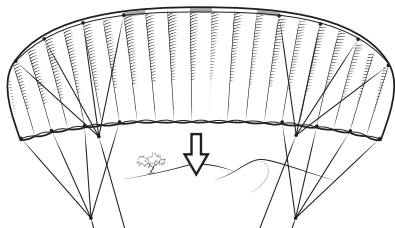

- 3 Secure the leader lines around a suitable object in a way that the backlines stay "braked" and flying up of the kite again is not possible.

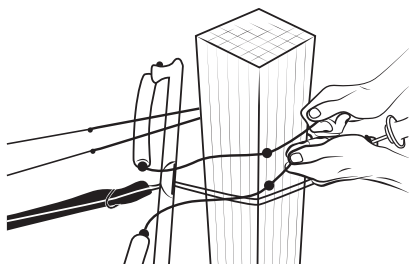

- 4 Secure the kite as described in "Securing the Kite".

Tip: When using this method it is also possible to walk your way up one of the steering lines to the kite, as long as the wind is light enough.

07.03 Self-landing using the Frontline Safety

- 1 Make sure that you have a large enough landing area that is free of any obstacles that can damage the kite. Fly the kite down to the right side of the wind window (e.g. the side that your frontline-safety line is attached to).

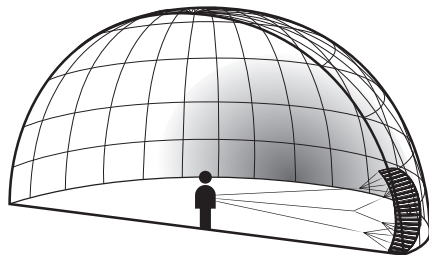

- 2 Activate your quick release. The kite will now flag out on the Front Line Safety and come to rest downwind of you.

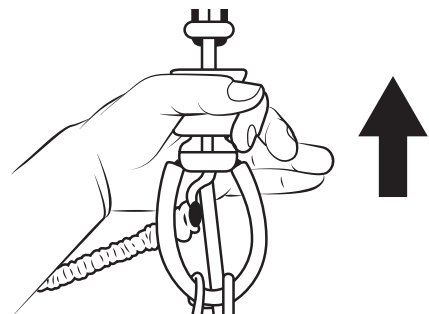

- 3 Attach the safety leash to a suitable object (e.g. a post or a board tightly buried in the sand) and work your way up to the kite a.s.a.p.

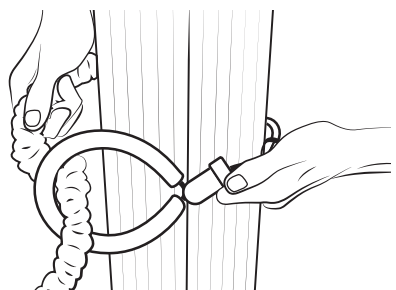

- 4 Secure the kite as described in "Securing the Kite".

08 SAFETY SYSTEM

- 1 The SOUL kites are equipped with a Frontline Safety (FLS). After triggering the Quick Release, the Control Bar will slide up to the stopper ball / knot.

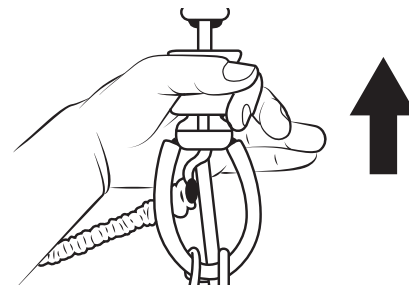

- 2 The kite will flag out on this single front line.

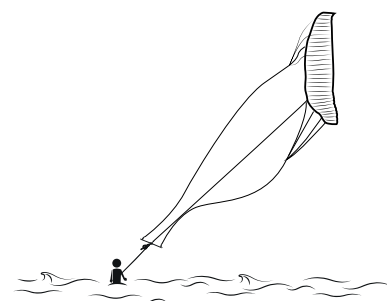

08.01 Reactivating the kite

After triggering it, it is possible to reassemble the Quick Release while on the water and start the kite again.

We recommend reading our Bar Safety Guide in detail!

- 1 Work your way up the safety endline until you get to the control bar. When you reach the bar, secure the endline to your harness hook. Now the quick release can be reset with both hands.

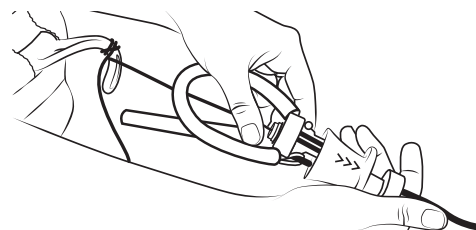

- 2 Hook in the chickenloop and secure it with the chickendick. Slowly release the endline bit by bit. Make sure that it has not wrapped itself around any part of your body. Do not let the endline slip too quickly through your fingers to avoid getting burns or cuts.

Tip: It can happen that the kite tangles after flagging out. If this cannot be solved by pulling on the steering lines, you can try to solve the problem by flagging out the kite again.

09 EMERGENCIES

In an emergency situation it is important not to panic, and to react purposefully and goal orientated.

Especially in very gusty conditions the kite can overfly its pilot. This can be corrected by powering up the kite by pulling the bar towards you or pulling in the leader lines (red and green). It is also possible to counter the kite's overflying, or get it back into the wind window by flying it back and forth.



Should the center of the kite collapse towards the pilot (e.g. frontstall) it is important to activate the quick release before it opens again, as the kite can develop a lot of power when it opens again in the wind-window.



A backwards flying kite (backstall) can be recovered by depowering (pushing the bar towards the kite). In very light winds you can grab hold of the adjuster and give short effective pulls to accelerate the kite.



If one is in danger of drifting away from the shore with an un-relaunchable kite, then it may be prudent to abandon the kite and swim back to shore if possible. Otherwise it is wise to stay with your kite, as it will make you easier to spot for rescuers.



Caution: It is very easy to get caught up in the bridle lines that are floating around. Avoid unnecessary swimming movements. A line knife in your harness is a very useful tool in a worst case scenario.



09.01 Self-Rescue with a foil kite

Packing down in deep water is only recommended for experienced kites and should be practiced beforehand.

- 1 Activate the quick release.

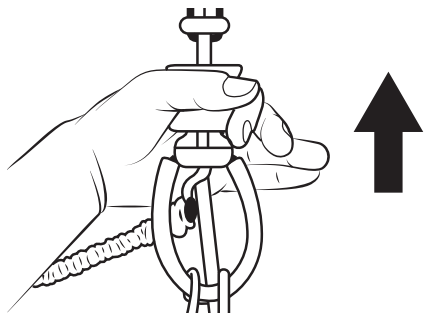

- 2 Work your way up the safety endline to the control bar. Wind the loose endline round the bottom of the bar in a figure of 8.

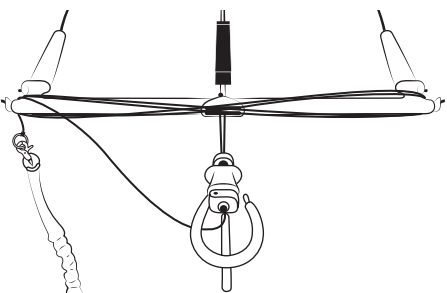

Tip: The flagged out kite can be pulled behind you on the safety leash when swimming back. However, this needs a lot of strength and is only recommended for very short distances.

- 3 Now roll the flying lines onto the bar and secure them with the bungies or even better using a half hitch.

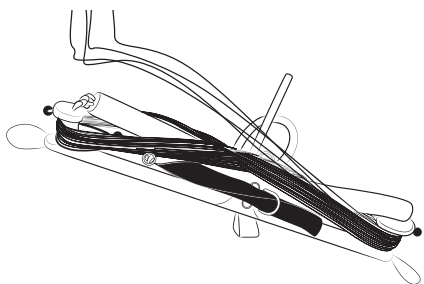

- 4 Grab the kite.



- 5 Lay the tips on top of each other, and then the bar on top and roll up the kite. Be careful with the bridle lines and stow them as best you can within the two halves of the kite when rolling it up. You can open the deflate valves to make rolling it up easier.

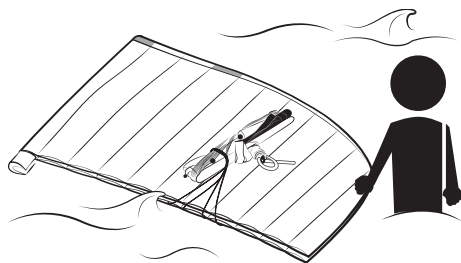

- 6 Secure the package with the harness.

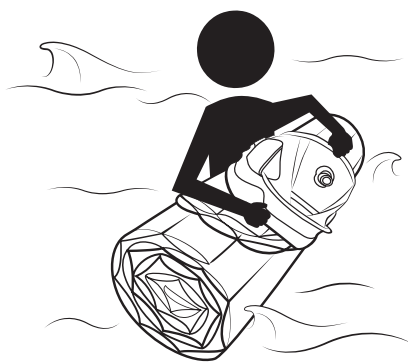

10 PACKING UP

A FLYSURFER kite can be packed into its bag very quickly. It is important that the bridle is securely packed inside the kite and the bar never gets into or goes through the bridle lines.

- 1 Open the deflate valves.

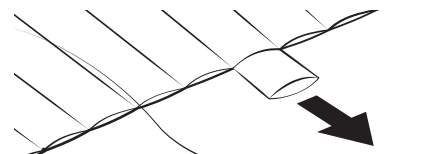

- 2 Wind the lines round the bar until you get to the mixer. Secure the lines with the elastics or a half hitch. Keep hold of the bar, or put it down somewhere out of the way of the bridle lines.

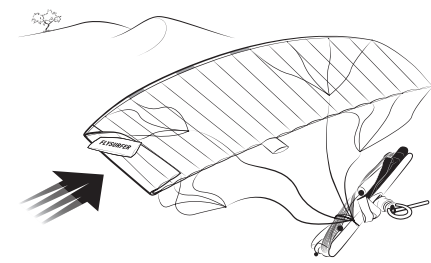

- 3 Fold the kite in half along the middle (tip on tip) and make sure that the bridle is inside both halves. Also make sure that there are no bridle lines over the outside skin.

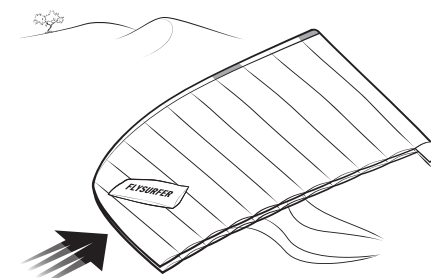

Tip: If you do not want to roll a wet bar into your kite, there is a method to attach the bar to the outside of the bag. Fold the kite in the middle (tip on tip) and then roll up the kite, including the bridle, and put it into the bag. Then roll up the bar and attach it to the outside of the kitebag.

- 4 Lay the bar on-top of the kite and a bit away from the tips

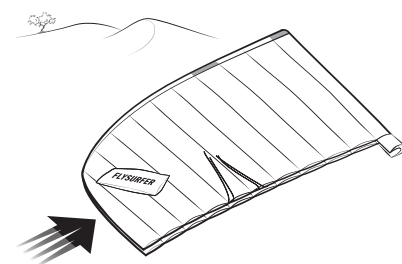

- 5 Throw the bridle lines in between the folded kite.

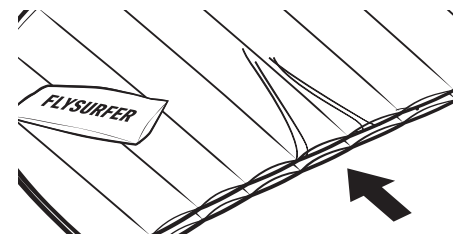

- 6 Roll up the kite around the bar. Make sure that no sharp objects on the beach damage the cloth.

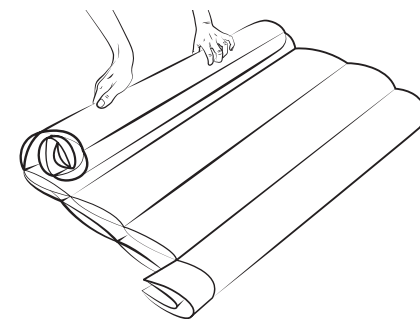

- 7 Close the deflate valves carefully and fold the kite on both sides of the bar and put it in the kitebag.

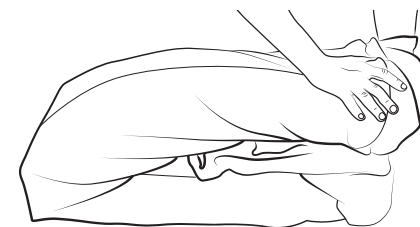

11 KITE CARE

FLYSURFER kites are very durable and very UV and saltwater resistant. With proper care, your kite may last even longer. Eventual color changes of the cloth can be caused by environmental causes, UV-exposure, mechanical strain as well as it getting dirty. A color change has no influence on the flight characteristics whatsoever and is not covered by warranty.

Do not leave the kite exposed to the elements

People who pack away their kite right after a session, or for a longer break, will minimise the amount of time the material is exposed to the sun and flapping in the wind, extending the "active" lifespan of their kite.

Drying

If a kite is packed away wet and left for a long period of time it can develop ugly mildew spots, rust on the metal parts or color bleeding of the cloth. This does not effect how the kite performs, but will reduce the value of your kite. In extreme cases the kite may get mouldy. To dry, simply continue to fly the kite until the canopy is dry

Tip: Drying of the kite can be accelerated when the kite is flown with an open air drainage valve on land. Otherwise a fan or hair-blower can help, but please never use hot air!

Rinsing

Rinse your kite from time to time with clear water, after using it in salt water, and leave it to dry in the shade. Do not use any detergents. The warranty will be void after the use of detergents on the cloth.

Check

Check all parts of the kite before each use. Especially parts that can wear out. Material failure on those parts can lead to further damages, or put the kite at risk.

12 MAINTENANCE

The main parts that wear on the kites are the Depower Line, the Safety Endline (see the bar manual), as well as the Sparepart Lines and the pulleys. Depending on use, the flying lines and other parts will need to be replaced within the lifespan of your kite. If you do not service these parts, it can lead to damage to the kite and will void the warranty.

12.01 Replacing the Sparepart Lines and Pulleys

The Sparepart Lines are the yellow lines that run through the pulley system known as the mixer. The sparepart line should be replaced before the sleeving could tear or fray (approx. 100 h). The pulleys should be changed after about 250 hours of use.

Before exchanging your sparepart lines, perform a mixertest to note down your current mixertrim. When exchanging sparepart lines, this trim will change and you might want to keep your preferred trim, after the line exchange you can then adjust to your previous setting.

Tip: Always exchange only one side at a time and use the other side as a template how the mixer should look like.

1 Lay out the kite and sort out the bridle. Make sure that the lines do not get crossed or mixed up through the whole procedure.

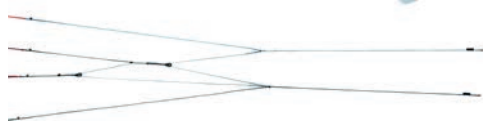

2 Disconnect the front and steering lines on one side. Undo the front- and back main lines at the mixer.



3 Pull the old sparepart lines out of the pulley. Always exchange both lines.



4 When exchanging a pulley (after 250h of use) concentration is needed. First make a larks head at the end of the line.



5 Put the pulley through the loop.



6 Pull the larks head knot tight.



7 Make sure to attach the new sparepart line in the same way as the old one.



8 The long sparepart line has a knot at the end, this knot is there to block the pulley from sliding over. Now pull the ring through the loop and attach to the flying line. Redo the front- and back main lines and pull the knots tight.

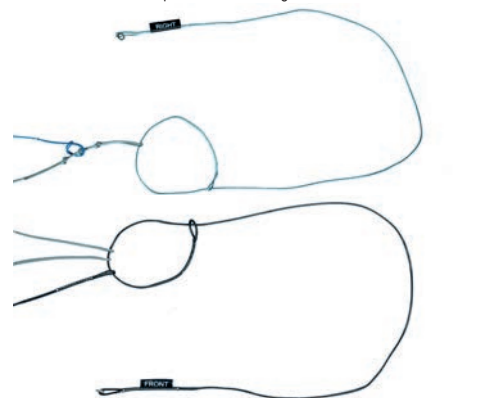

9 Reconnect the flying lines again, and then repeat the same procedure on the other side. Pull all knots tight and check the bridle carefully.

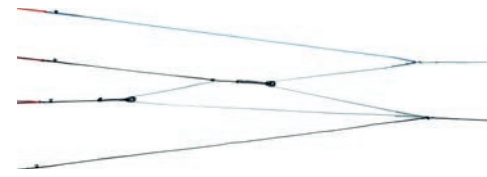

Warning: After exchanging the sparepart lines, do the bridle check and adjust the camber trim system accordingly.

12.02 Little Connection Lines

The "Little Connection Line" (LCL) allows you to quickly exchange a bridle line and also works as a predetermined overload weak point that prevents the canopy from getting damaged. Should an LCL break, replace it with new one, in the same colour (same breaking strength) LCL.



12.03 Repairing the Cloth

In case you get a small tear (e.g. through contact with a sharp object) we have included a repair kit with your kite. The area that needs to be repaired must be clean, dry and grease-free. Temporary repairs are possible with spinnaker repair tape, but the tear should be taped from the inside of the kite. It is recommended that you round off the edges of the repair tape. A special binding agent (silicone sealing compound) for the X-Light Cloth is available through Flysurfer sales partners or directly at FLYSURFER. A repair manual is included with the binding agent. There is the possibility to have a professional repair done by us. We can exchange whole parts of the canopy, so that there will be no trace of the damage.

Tip: When a tear is close to a seam (less than 5cm), we recommend using sewing to repair the damaged area.

13 TRIMMING

As all lines change length over time, we have built in a way to correct the flying characteristics quickly and easily. Adjustments after heavy use over years should be done to keep the products performance and ensure a long-term use of the SOUL.

13.01 Mixer

Bridle levels of the kite are controlled by the mixer, a pulley system which modulates the angle of attack and the profile camber. The mixer features the **two-ring camber trim system**.

13.02 Camber Trim System

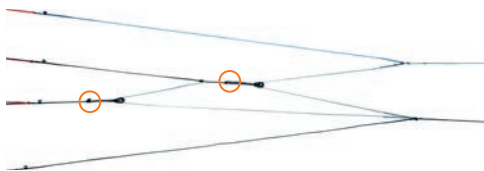

1 Sort out the mixer. Hold the loops next to the little flags in line and set A & Z on the same level.



2 Now tension the mixer and secure the ends of the front and steering lines (e.g. an assistant can hold them). The position of the lines should not change during the whole mixer test.



3 Bring the C-Level up to the A and Z bridle connection knots and tension the mixer (min. 5 kg tensile load per line). All three knots should be at the same level at standard trim.



4 If this is not the case, you just have to move the metal ring of the mixer (C-Level) until all 3 knots are at the same level.



Tip: The mixer is basically a 2:1 pulley system. If you want to change the B-Level by one centimeter, you will need to move the ring by two centimeters.

5 Bring the B-Level up to the A, C and Z bridle connection knots and tension the mixer. All four knots at the same level create a standard factory trim (+/- 0cm).



6 If this is not the case, you just have to move the metal ring of the mixer (B-Level) until all 4 knots are at the same level.



7 Done. Be sure to pull everything properly tight again after adjusting, so that the trim stays under tension.

Tip: When the mixer is set to the standard trim (+/- 0cm), e.g. all four knots are at the same level. It is enough to only move the metal ring of the mixer (C-Level) to change the basic trim. The B-Level automatically adjusts half the amount of the CLevel when modifying.

13.03 Bridle-Check

The bridle check can be done by measuring and comparing the knots of the black marked lines at the canopy to compensate stretch or shrink of the bridle. The individual levels of the kite are controlled with different ratios by the Mixer and thus influence the angle of attack and the curvature of the profile. The trim checker helps with the bridle check.

The **Trim Checker** serves as an aid to fix the front main and back main lines. It can be attached to objects with a Larkshhead and enables you to carry out the bridle check yourself.



1 Attach the trim checker to an unmoveable object.



2 Sort the mixer first. Connect the ends of the trim checker to the front main- or back mainline in any order.



3 Move to the kite. Take the black marked line of the A and Z level in your hand. Pull evenly on both lines to bring the level of the knot above the mark. Increase the pull to 5kg to lock the trim checker.



Note: The trim checker can be loosened again by moving your hands alternately without moving away from the kite.

4 Keep the A-level under tension. Then compare it with the black marked lines of the B- and C-level. Bring the C-Level up to the A-Level and tension the mixer (min. 5 kg tensile load per line). All knots should be at the same level at standard trim.

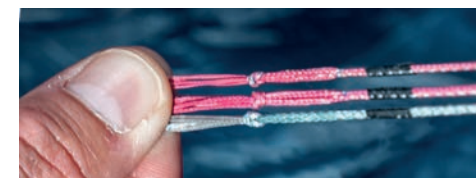

5 If this is not the case, you just have to move the metal ring of the mixer (C-Level) until all 3 knots are at the same level.



Tip: The mixer is a 2:1 pulley system. If you want to change the B-Level by one centimeter, you will need to move the ring by two centimeters.

6 Bring the B-Level up to the A, C and Z Levels and tension the mixer. All four knots at the same level create a standard factory trim (+/- 0cm).



7 If this is not the case, you just have to move the metal ring of the mixer (B-Level) until all 4 knots are at the same level.



Be sure to pull everything properly tight again after adjusting, so that the trim stays under tension.

13.04 Profile Moment Adjuster (PMA's)

Note: It is important to check the kite first as it is shown in the bar manual in the trim check section. Changing the PMAs should only be done by a professional when the bar, lines, mixer, bridle and sail have been checked.



The PMAs are knot ladders that are sewn onto the profile in inside the foil kite. They sit on the upper and lower sail between the A and B levels. Thereby the aerofoil can be directly adjusted as illustrated below.

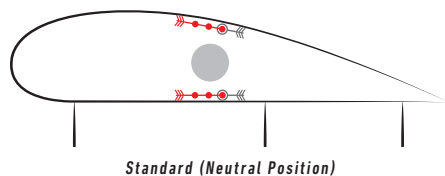

If you shorten a PMA on the top of the wing, the aerofoil becomes slower and more stable.

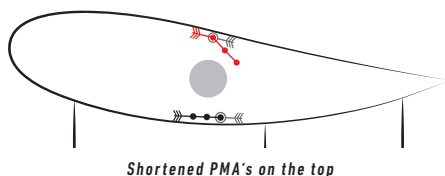

If you shorten a PMA on the bottomside of the wing, the aerofoil becomes faster and the wing tips are more likely to fold.

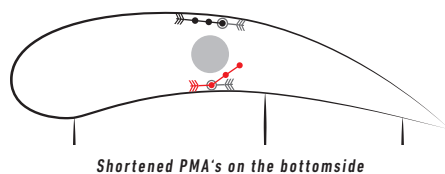

Caution: Shortened PMA's on the bottomside are only recommended for experienced foilkite users.

The PMA's are located along the ribs on both upper side and bottom side of the wing on the following positions:

Positions 6 / 8 / 10 / 12

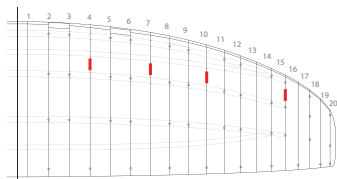

Positions 15 / 18

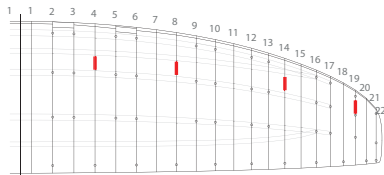

1 Reach into the closest air intake valve to get to the PMA.



2 Pull it out through the outer opening.



3 Adjust the PMA by moving the larks-head-knot.



Generally it is possible to shorten the PMA's by up to two knots, but one is okay for most users.

Tip: We recommend to adjust every second PMA first. Then test the kite and if still needed adjust each one.

13.05 Optimum trim of the flying lines

Steering (back) lines shorten over time in relation to the flying (front) lines. Underneath the floaters, the back line can be shortened or extended by using knots. Extension of the back lines is necessary when the trimmer needs to be pulled in too much to keep the kite flying normally in its intended wind range. (back-stall tendency).



Performance Tuner

The performance tuner is a knot ladder integrated into the C-Pulleyline to modify the camber of the kite. Move the Z-Main Line on the knot ladder to affect performance and control bar forces.

1 By default, the line sits below the center knot. This trim variant offers balanced control bar forces as well as performance and stability.



2 Moving the Z-Main Line on the knot ladder towards the kite: Lengthening the line softens control bar forces and reduces backstall. This trim variant allows the kite to fly further toward the edge of the wind window. We recommend it in the upper wind range.



3 Moving the Z-Main Line at the knot ladder towards the control bar: Shortening the line increases control bar forces and the kite is more cambered. This trim variant allows the brakes to engage earlier and improves the responsiveness of the kite. We recommend them in combination with twin tips or for wave riding.



14 REPAIR & SPARE PARTS

Repairs can be done at either our workshop in the head office, or by a FLYSURFER sales partner who offers a repair service. High quality original spare parts for all our FLYSURFER products can be ordered directly from our Online-Shop:

<http://shop.flysurfer.com>

FLYSURFER

FLYSURFER
Brand of Skywalk GmbH & Co. KG
Windeckstr. 4
83250 Marquartstein, GERMANY

For further information please visit: www.flysurfer.com