



FLYSURFER

**USER
MANUAL
PEAK⁵**

EN

CONTENT

01	Release of Liability	4
02	Safety Notes	5
02.01	Do not fly with kites.....	5
03	Overview of the Kite	6
04	Handling	8
04.01	Setting Up a Single-Skin Kite.....	8
04.02	Sorting the bridle.....	9
04.03	Securing a Single-Skin Kite.....	9
05	Launching	10
05.01	Self launching at the edge of the wind window.....	10
05.02	Edge of the wind window with an assistant.....	10
05.03	Powerzone.....	11
06	Relaunch	12
06.01	Reverse Launch.....	12
06.02	One Line Relaunch.....	12
07	Landing	13
07.01	Landing with an assistant.....	13
07.02	Landing without an assistant at the side of the wind window.....	13
07.03	Self-landing using the B-Safe System.....	14
08	Safety Systems	14
08.01	Frontline Safety (FLS).....	14
08.02	B-Safe System (5th line).....	14
08.03	Reactivating the kite.....	15
09	Emergencies	15
10	Packing Up	16
11	Kite Care	17
12	Assembly of the B-Safe System	17
12.01	Conversion of the CONNECT ² Control Bar from 4 lines Frontline Safety to 5 lines B-Safe System.....	17
12.02	Instalment of the B-Safe Top Lines.....	18
13	Maintenance	19
13.01	Replacing the Sparepart Lines and Pulleys.....	19
13.02	Little Connection Lines.....	20
13.03	Repairing the Cloth.....	20
14	Trimming	20
14.01	Mixer.....	20
14.02	Camber Trim System.....	20
14.03	Optimum trim of the flying lines.....	21
15	Repair & Spare Parts	21

01 RELEASE OF LIABILITY

Release of liability, claim waiver, assumption of risk

By assembling and/or using this FLYSURFER product, you agree that you have read and understood the entire FLYSURFER product manual, including all instructions and warnings contained in that user manual, prior to using the FLYSURFER product in any way. You additionally agree that you will ensure any additional or subsequent user of your FLYSURFER product will read and understand the entire FLYSURFER product user manual, including all instructions and warnings contained in that user manual, prior to allowing that person to use your FLYSURFER product.

Assumption of Risk

FLYSURFER product and any of its components involve certain risks, dangers, and hazards that can result in serious personal injury and death to both the user and to non-user third parties. In using this FLYSURFER product, you freely agree to assume and accept any and all known and unknown risks of injury and you and third parties while using this equipment. The risks inherent in this sport can be greatly reduced by abiding by the warning guidelines listed in this user manual and by using common sense.

Claim Waiver

Release and waiver of claims in consideration of the sale of the FLYSURFER product to you, you hereby agree to the fullest extent permitted by law, as follows:

To waive any and all claims, that you have or may in the future have against Skywalk GmbH & Co. KG and all related parties resulting from use of the FLYSURFER Product and any of its components. To release Skywalk GmbH & Co. KG and all related parties from any and all liability for any loss, damage, injury or expense that you or any users of your FLYSURFER product may suffer, or that your next of kin may suffer, as a result of the use of the FLYSURFER product, due to any cause whatsoever, including negligence or breach of contract on the part of Skywalk GmbH & Co. KG and all related parties in the design or manufacture of the FLYSURFER product and any of its components. In the event of your death or incapacity, all provisions contained herein shall be effective and binding upon your heirs, next of kin, executors, administrators, assigns, and representatives. Skywalk GmbH & Co. KG-related parties have not made and expressly deny any oral or written representations other than what is set forth herein and the FLYSURFER User's Manual.

If you have any questions (repair, replacement parts installation, tuning, etc.) the dealers you trust get faster help and correspondingly cheaper support (e.g. by saving shipping costs).

You can find all dealers in your area via our partner map:

<https://flysurfer.com/fs-partner/>

If you need further help, you can reach us at headquarters by phone or email.

E-Mail: support@flysurfer.com

Phone: +49 (0) 8641 6948 0

02 SAFETY NOTES

Read the entire online user manual thoroughly before using the product, and strictly confirm to the procedures noted. **The following safety guidelines are only guidelines and do not claim to cover every instance.**

01. Kitesurfing is a **potentially dangerous sport**, that holds risks for the athlete or the people surrounding them. Incorrect use of this product may result in **serious injury or even death** for the user or third parties. Every user should be qualified by a FLYSURFER kiteschool or a FLYSURFER dealer.
02. The user carries the **sole responsibility** for themselves and third parties when using this product. The user must check their equipment for wear, especially wearing parts, before each kite session. Do a test activation of your quick release before every launch. This will ensure the system is working and reinforces the release instinct of the kiter.
03. The product may only be used with **original spare parts**, and may not be modified.
04. This product has been designed for riders weighing 40-120kg. We cannot guarantee the proper functioning of the product outside of this weight range.
05. Never kite in unsuitable conditions such as storm fronts, lightning, or offshore winds. Check the weather and wind conditions carefully and choose the according kite size.
06. Check out the kiting spot beforehand. Make sure you are aware of any risks and dangers such as obstacles, shallows, currents and bans. Also be aware if a rescue craft can get to you in case of an emergency. It is always best to ask people (locals) who know the area well.
07. Keep a safety margin of at least two line-lengths downwind of you, and never kite near people or obstacles. Kiting near powerlines, roads, airports, cliffs, etc. is extremely dangerous.
08. Make sure that someone is looking out for you and that help is there if you need it. Never go out alone. Never kite further away from shore than you can swim back.
09. The incorrect usage of lines creates a high risk of injury for yourself as well as others. Body parts that get caught in the lines of the kite may suffer from severe injury or burns.
10. Only use bars with a safety system that you can open in emergency situations. Use a quick-release kite leash so that you can disconnect your body from the product in case of an unforeseeable emergency.

02.01 Do not fly with kites

A kite is not designed, tested or licensed as an aircraft or flying device. The use of a kite as a flying device is illegal and not covered by insurance. **Flying with this product can lead to death!**

03 OVERVIEW OF THE KITE

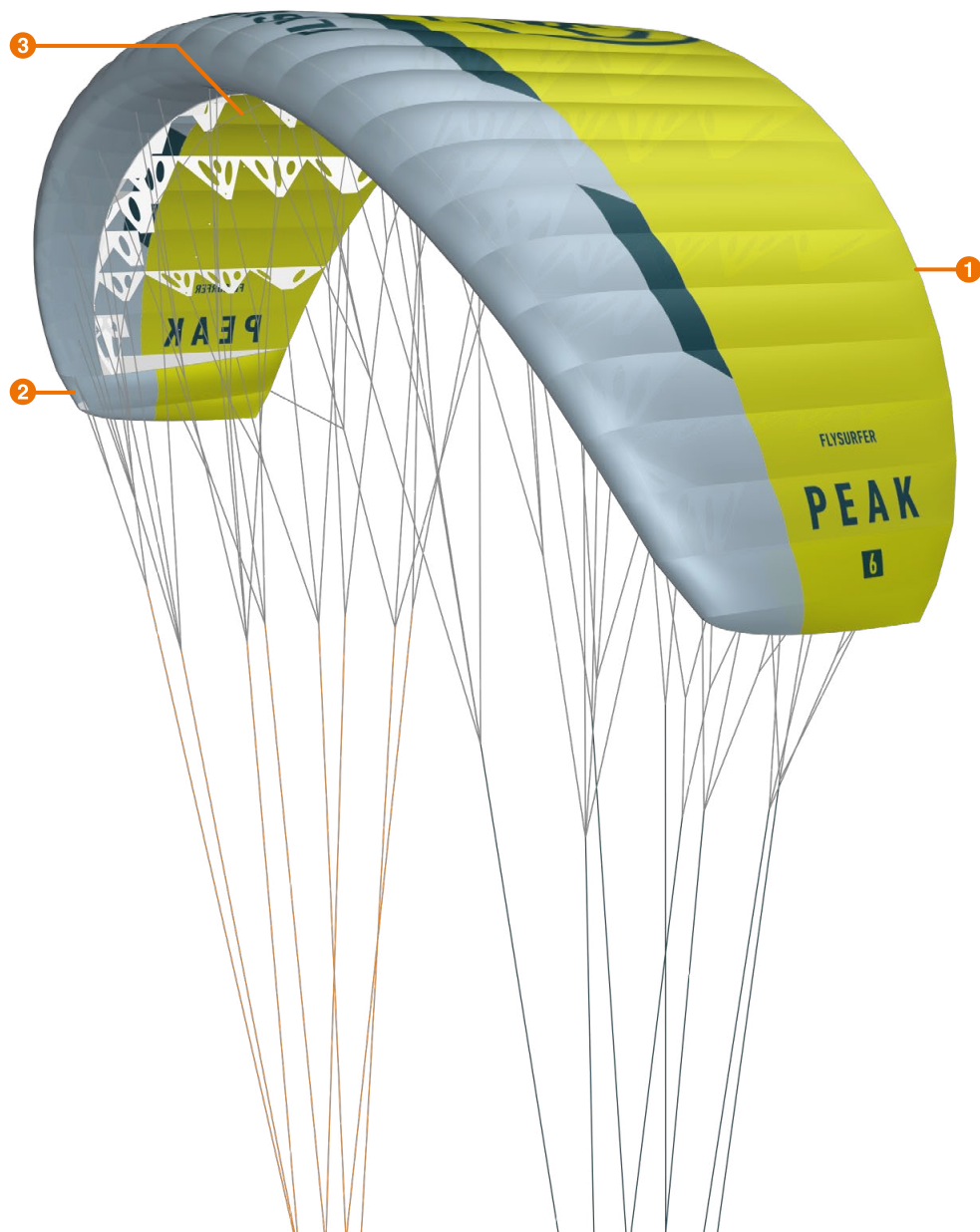

1 TX-Light Single Skin Concept

The single skin concept has high buoyancy profiles and a very efficient depower. Reducing its weight to a minimum brings advantages in terms of stability, drift and light wind handling. Single skins allow the use of our B-Safe system and absorb hard impacts. The excellent longevity of these kites is not only due to the concept but by their material. High ageing and tear resistance, three ripstop threads and enormous rigidity at only 33g / m² make the TX-Light the perfect fabric. The leading edge consists of 44g / m² DLX+ cloth, protects against abrasion and sharp-edged objects. Every material optimizes a specific area of the kite. We use UV-resistant surfaces and air-tight coatings to absorbent properties to improve airflow when wet.

2 Hybrid Wingtip Technology

The Hybrid Wingtip Technology consists of two self-inflating cells on each side of the kite. The openings are protected with mesh material to prevent the entry of snow or dirt. Both wingtips have our proven drainage system. The more efficient aerodynamics allow for tighter turning with constant pull, as well as increased backstall resistance. Through that, the wingtip is only flapping when you depower the kite. The bar feedback is considerably improved. The kite feels sporty and gives you a confidence-inspiring feeling.

3 B-Safe System

The B-Safe System is a (extra optional Y-) line configuration that slides along the B-level through eyelets. After activating the quick release, the bar moves 4 m up on the 5th line. The kite is reefed horizontally in the middle and reduces the wing span to a minimum. The kite comes down gently and flags out. After reactivating the quick release system, you can launch the kite through the power zone. The B-Safe System is ideal for self-landing or for taking breaks.

+ Camber Trim System

Bridle levels of the kite are controlled by the mixer, a pulley system which modulates the angle of attack and the profile camber. The mixer features the two-ring camber trim system. Moving the rings changes the relationship between the B or C level relative to the A level. The profile of the foil kite can be trimmed to be either flat or curved.

04 HANDLING



A kite needs to be secured properly even if the wind is light. A runaway kite can be a serious danger to people or animals downwind. To ensure a long lifespan of your kite, we recommend that you do not leave the kite flapping in the wind and sun for long periods.

04.01 Setting Up a Single-Skin Kite

1 Lay the kite out on a surface free of hard or sharp objects. Unroll your kite upside down into the wind and secure it with something that has no sharp edges and is heavy enough to hold down the kite for the given wind.

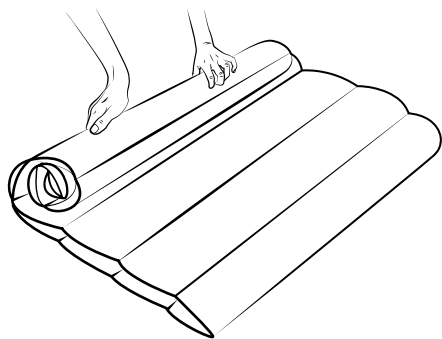

2 Place the bar far enough away from all bridle lines on the trailing edge side of the kite. Make sure that the bar cannot fall or be pulled into the bridles.

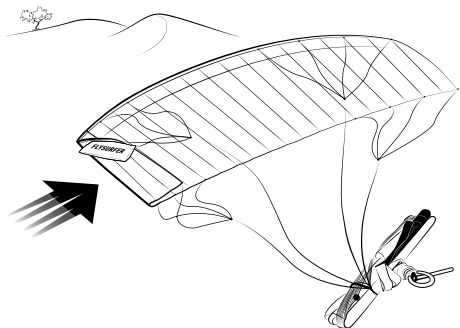

3 Check your bridle for tangles. Make sure that none of the lines are caught around the back of the kite.

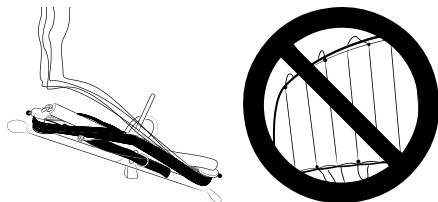

4 Start at the leading edge holding up the front lines to visually check the bridle step by step.

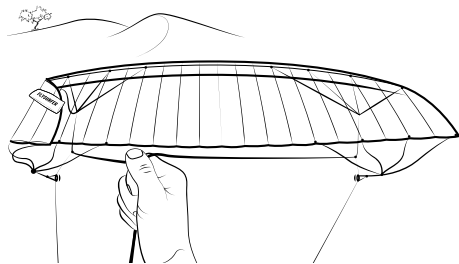

5 When the bridle is sorted out, lay the front lines to the inside and the steering lines to the outside. If not, follow the tips on the "Sorting out the bridle" chapter.

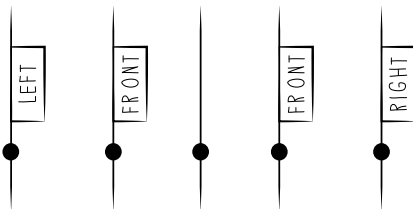

6 Ensure your flying lines are connected correctly and clear of any potential hazards. Check for any damage or knots.

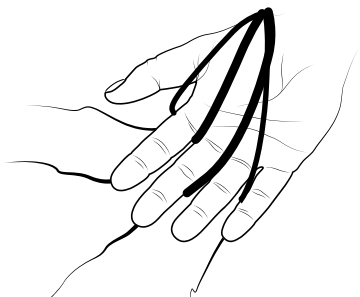

7 If the lines are still twisted, untwist them by turning the bar. It may be possible (especially after not being careful when packing away or setting up the kite) that the bar has to be pushed through the lines again to untwist.

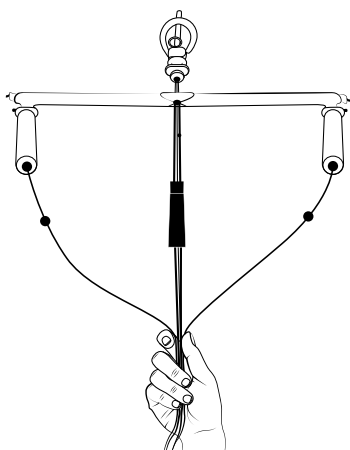

04.02 Sorting the bridle

Even a badly tangled bridle can be quickly sorted out with the right technique.

1 Roll up your lines onto the bar until you get close to the mixer and secure the lines with a half hitch and/or the bungee cord.

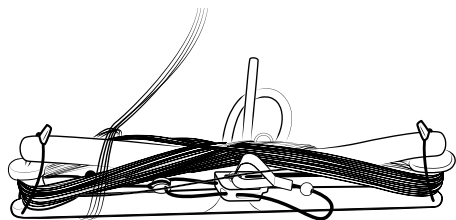

2 If necessary, undo loops, knots, or balls of balls. Most loops can be loosened by pushing the bar through along the line.



3 Lightly tension up the bridle again to check it. If necessary, repeat the last step till the left and right bridles are separated.

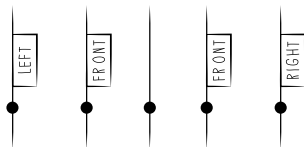

4 Unroll the lines from the bar and check as before.

04.03 Securing a Single-Skin Kite

1 Fold your kite in the middle and let the tips flow out downwind. The bottom sail and the bridle will be facing inwards. Weigh down the kite in the front third of the top sail. This method prevents the tips from flapping in the wind. Opening the deflate valve(s) can also help.

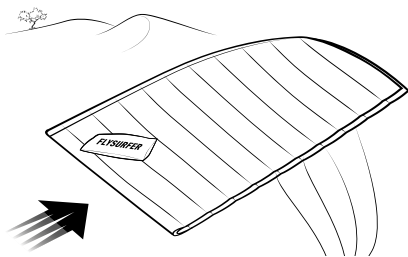

Tip: The kite can also be secured using the same method as the launch. However, it has been proven that the above method keeps the kite more still in higher winds.

2 Make sure that the tips are not flapping too much. This can lead to the bridle tangling. The tips can be additionally secured with a bit of sand or other suitable object.

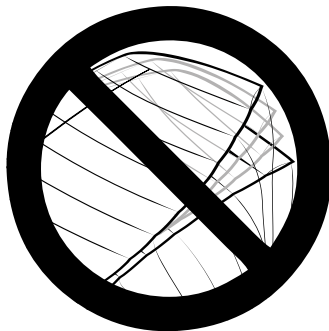

05 LAUNCHING

Please check not only the wind and weather conditions, but also all your equipment, especially the safety system before launching. Do not use any kite outside of its recommended upper wind range. When launching in strong winds, we recommend that you have an assistant holding you from the back of your harness. During launching, always pay attention that your bridle lines do not get caught on anything or become tangled.

05.01 Self launching at the edge of the wind window

- 1 Lay the kite out 90° to the wind. Fold over the windward wingtip and secure it near the leading edge.

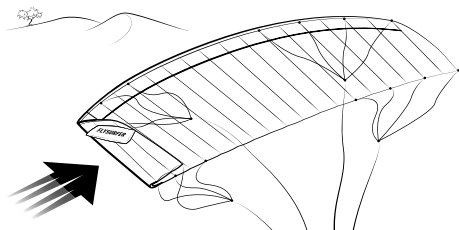

- 2 The kite should be positioned 15-30° downwind of you when you slowly tension the lines for launch.

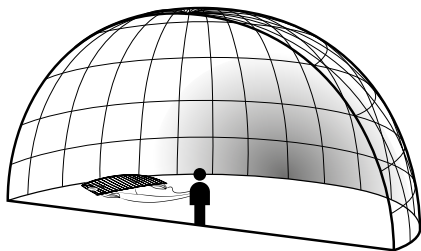

- 3 Pay attention that the downwind wingtip does not fold over upwind.



- 4 Release the kite from the sand or object securing it with a step backwards away from the kite and carefully steer it.

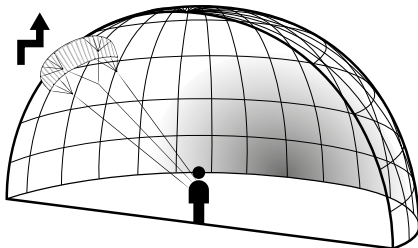

Tip: You can prevent the lines getting caught around the bottom wingtip by folding over the tip once more and securing the second fold with e.g. sand.

05.02 Edge of the wind window with an assistant

It is important that your assistant is experienced with this technique and you have explained them how it's done.

- 1 Position kite and assistant exactly on the edge of the window.

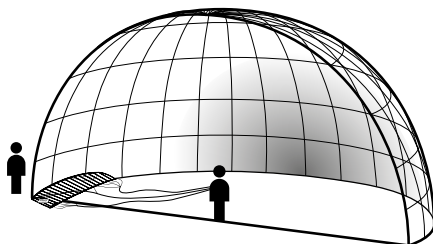

- 2 The assistant begins from the center of the kite with the leading edge (LE) into the wind. As the kite shapes its form, the assistant slowly works his hands down the leading edge until the kite is fully opened and lets the kite rise up. The bottom tip should not be touching the ground anymore.

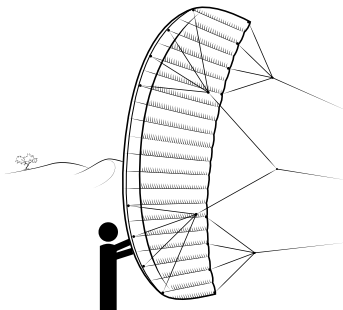

③ As soon as the kite is inflated and you are ready, give the assistant the thumbs up signal that he can let go. Make sure to once again check whether all lines run freely before doing this.

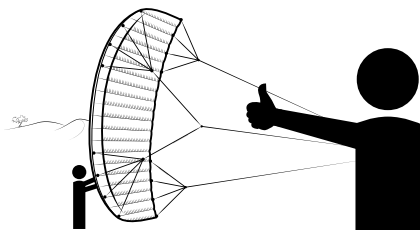

② Put the flying lines under tension so that the kite rises slowly. Take another step to windward to release the weight from the trailing edge of the kite.

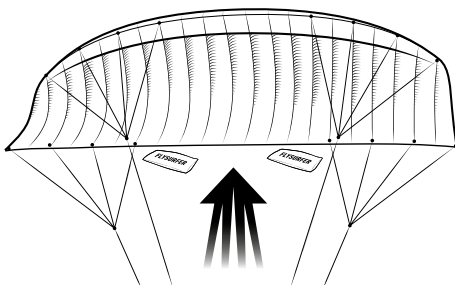

Note: Get aligned with the wind, the assistant retains his position and is not moving around.

③ Depower the kite until it reaches the zenith.

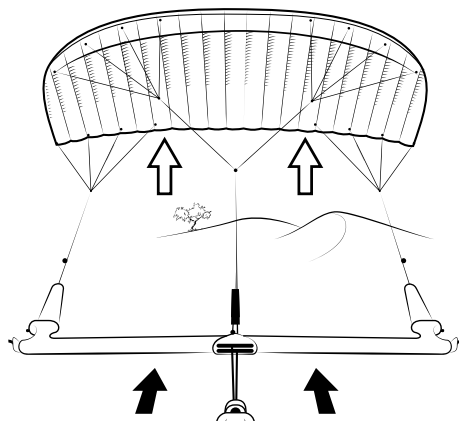

05.03 Powerzone

Important: Only start a kite in the power zone in light wind, otherwise it can develop large forces/power spikes. Always keep a large safety distance downwind of yourself.

① After setting up the kite in the power zone make sure to weigh the trailing edge with suitable objects or sufficient sand or snow.

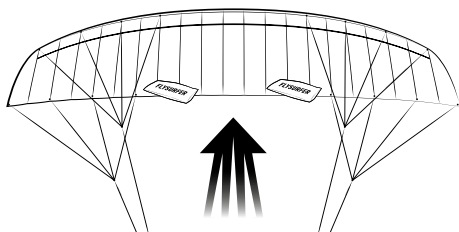

06 RELAUNCH

06.01 Reverse Launch

1 Grab the leader lines above the floaters as high up as you can. Make sure that the bar is the right way up. Do not cross over your hands.

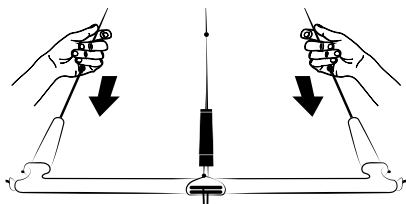

2 Pull in both leader-lines as far towards yourself as possible to reverse the kite off the ground. Strong pulls or pumping the lines may help in light winds. If the kite does not release from the ground, grab the leader lines higher up.

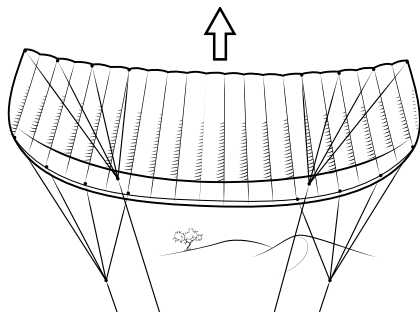

3 When the kite is at least one wingspan above the ground, let go of one of the leader lines. Make sure you keep hold of the other one and the bar is in the right position.

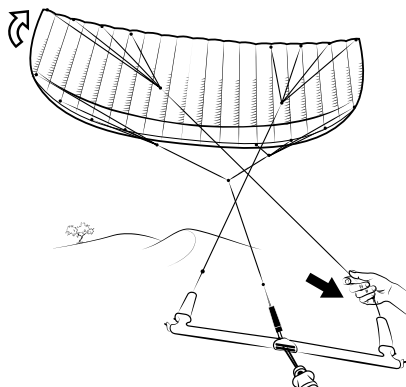

4 The kite will now spin around. As soon as the leading edge of the kite points up let go of the remaining leader line and put your hand back on the bar. Depower the kite till its back in the sky towards the zenith.

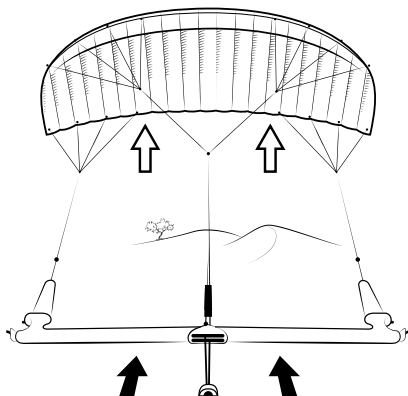

Tip: The reverse launch is the recommended relaunch method when kiting on solid terrain. This minimises potential damage from abrasion.

06.02 One Line Relaunch

1 Grab one steering line high above the floater. Pull back the line far enough towards you so that the kite starts to peel to the side you are pulling. Keep pulling until the kite launches at the edge of the wind window.

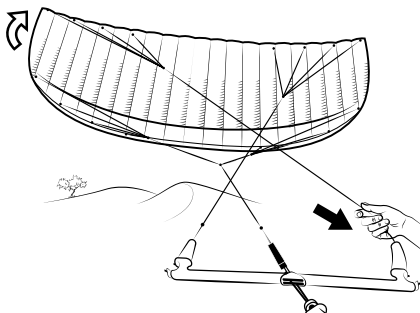

If the kite does not lift up and peel to one side when pulling the leader line, try pulling the opposite leader instead. If this still does not work, then use the reverse launch method.

2 Let go of the steering line as soon as the leading edge of the kite points up. Grab the bar and keep it depowered until the kite is flying again.

07 LANDING

07.01 Landing with an assistant

1 The easiest and safest way to land your kite is with the help of an assistant. Signal a trained assistant that you want to land. The assistant should be standing well upwind of the kite.

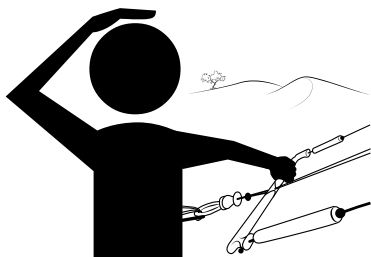

2 Lower the kite towards the assistant along the edge of the wind window.

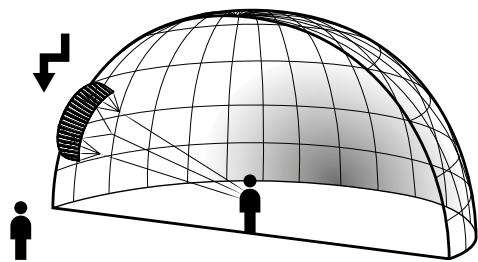

3 The assistant can now approach the kite and grab hold of the leading edge of the kite.

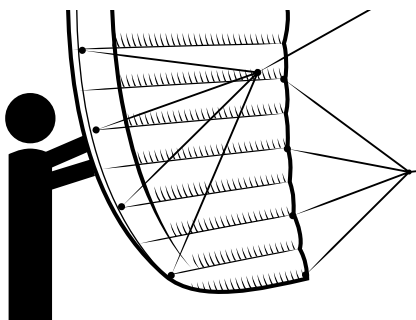

Warning: The assistant should never grab any lines.

4 As soon as the assistant has the kite securely in their hands, walk towards them until all flying lines are no longer under tension. This way the kite will flag out downwind of the assistant.

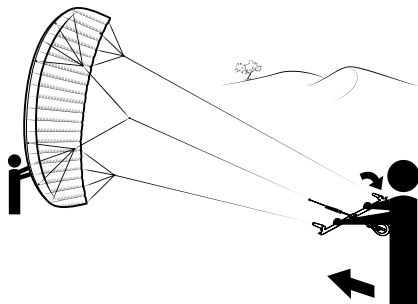

5 Secure the kite as described in "Securing the Kite".

07.02 Landing without an assistant at the side of the wind window



Warning: Keep at least two line-lengths safety distance downwind. We generally recommend landing with the help of an assistant. Landing the kite by backstall should only be attempted in light winds.

1 Fly down the kite on the edge of the wind window.

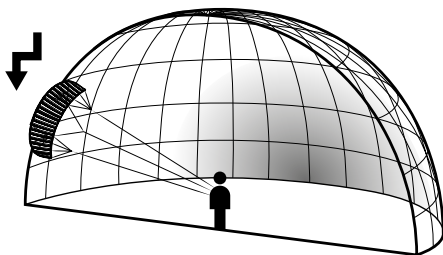

2 Steer the kite down hard so that the kite collapses on the ground.

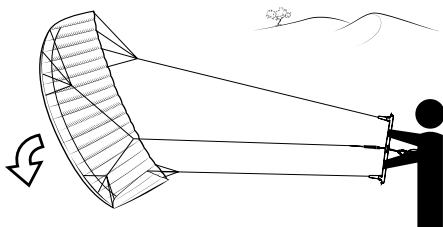

- 3 Go quickly toward the kite until it comes to rest entirely on the ground.

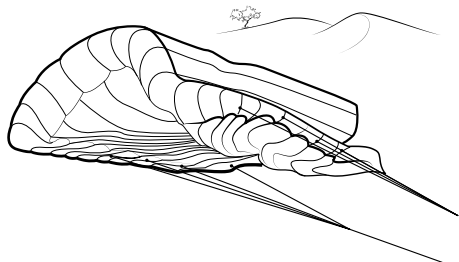

- 4 Secure the kite as described in "Securing the Kite".

07.03 Self-landing using the B-Safe System

Make sure that you have a large enough landing area that is free of any obstacles that can damage the kite.

- 1 Activate the quick release and the kite falls powerless from the sky. Optionally, you can pull on the 5th line until the kite falls pressureless from the sky.

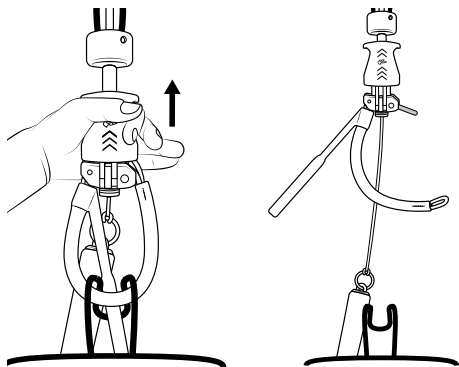

- 2 Attach the safety leash to a suitable object (e.g. a post or a board tightly buried in the sand) and work your way up to the kite a.s.a.p.

- 3 Secure the kite as described in "Securing the Kite".

Tip: The kite can also be landed in a controlled manner (by backstalling) by pulling slightly on the safety leash without activating the quick release.

08 SAFETY SYSTEMS

08.01 Frontline Safety (FLS)

In standard settings, all PEAK® kites operate on a Frontline Safety System (FLS). We recommend the use of FLYSURFER Control Bars to ensure the functionality of the Frontline Safety System.

- 1 After triggering the quick release, the Control Bar moves up to the stopper knot.

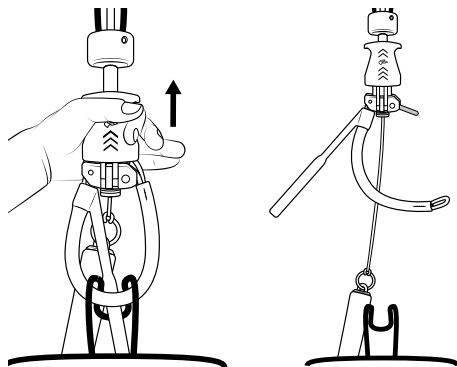

- 2 The kite flags out along the FLS-Line.



08.02 B-Safe System (5th line)

You can convert every PEAK® to use the B-Safe System. The lines required for the installation are included in the scope of delivery. We recommend our CONNECT² Control Bar to ensure the functionality of the B-Safe system.

- 1 After triggering the quick release, the Control Bar moves along the B-Safe line in the direction of PEAK.

② The kite is gathered up and falls from the sky without pressure. This method is suitable for self-landing. Using the B-Safe system offers the highest level of security!

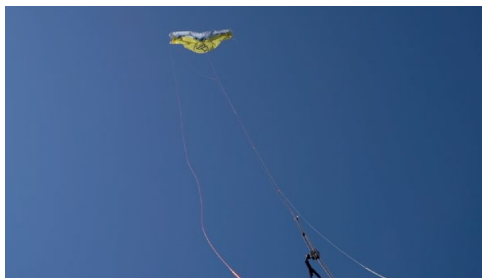

08.03 Reactivating the kite

After triggering the Quick Release, it is possible to reassemble it and start the kite again.

We recommend reading our Bar Safety Guide in detail!

① Work your way up the safety endline until you get to the control bar. When you reach the bar, secure the endline to your harness hook. Now the quick release can be reset with both hands.

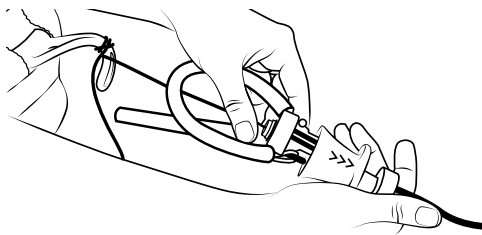

② Hook in the chickenloop and secure it with the chickendick. Slowly release the endline bit by bit. Make sure that it has not wrapped itself around any part of your body. Do not let the endline slip too quickly through your fingers to avoid getting burns or cuts.

Tip: It can happen that the kite tangles after flagging out. If this cannot be solved by pulling on the steering lines, you can try to solve the problem by flagging out the kite again.

09 EMERGENCIES

In an emergency situation it is important not to panic, and to react purposefully and goal orientated.



Especially in very gusty conditions **the kite can overfly** its pilot. This can be corrected by powering up the kite by pulling the bar towards you or pulling in the leader lines (red and green). It is also possible to counter the kite's overflying, or get it back into the wind window by flying it back and forth.



Should the center of the kite collapse towards the pilot (e.g. frontstall) it is important to activate the quick release before it opens again, as the kite can develop a lot of power when it opens again in the wind-window.



A **backwards** flying kite (backstall) can be recovered by depowering (pushing the bar towards the kite). In very light winds you can grab hold of the adjuster and give short effective pulls to accelerate the kite.



If one is in danger of drifting away from the shore with an un-relaunchable kite, then it may be prudent to abandon the kite and swim back to shore if possible. Otherwise it is wise to stay with your kite, as it will make you easier to spot for rescuers.



Caution: It is very easy to get caught up in the bridle lines that are floating around. Avoid unnecessary swimming movements. A line knife in your harness is a very useful tool in a worst case scenario.

10 PACKING UP

A FLYSURFER kite is quickly packed. Make sure that the bridle lines are stored securely inside the kite and the control bar does not get caught between them.

1 Wind the lines round the bar until you get to the mixer. Secure the lines with the elastics or a half hitch. Keep hold of the bar, or put it down somewhere out of the way of the bridle lines.

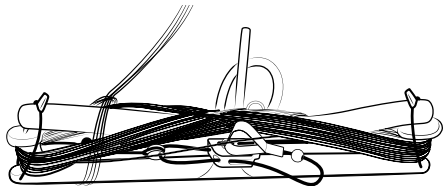

2 Fold the kite in half along the middle (tip on tip) and make sure that the bridle is inside both halves. Also make sure that there are no bridle lines over the outside skin.

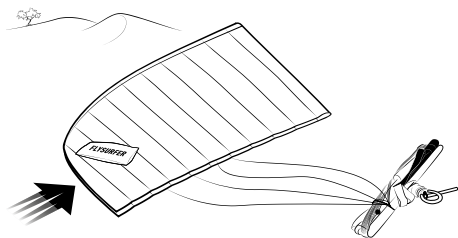

Tip: If you do not want to roll a wet bar into your kite, there is a method to attach the bar to the outside of the bag. Fold the kite in the middle (tip on tip) and then roll up the kite, including the bridle, and put it into the bag. Then roll up the bar and attach it to the outside of the kitebag.

3 Lay the bar on-top of the kite and a bit away from the tips.

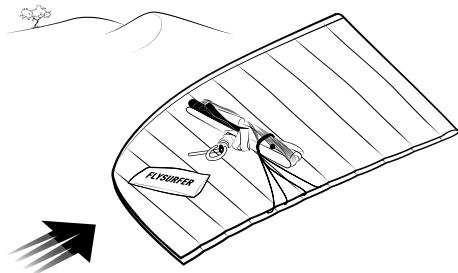

4 Lay the bridle lines in between the folded kite.

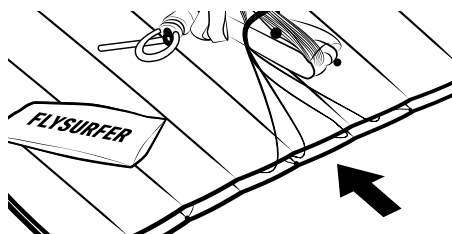

5 Roll up the kite around the bar. Make sure that no sharp objects on the beach damage the cloth.

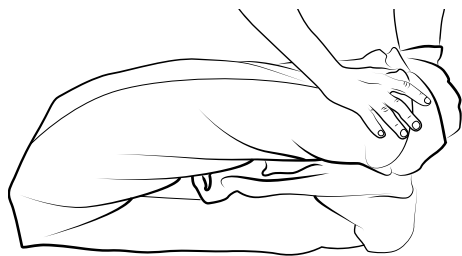

11 KITE CARE

FLYSURFER kites are very durable and very UV and saltwater resistant. With proper care, your kite may last even longer. Eventual color changes of the cloth can be caused by environmental causes, UV-exposure, mechanical strain as well as it getting dirty. A color change has no influence on the flight characteristics whatsoever and is not covered by warranty.

Do not leave the kite exposed to the elements.

People who pack away their kite right after a session, or for a longer break, will minimise the amount of time the material is exposed to the sun and flapping in the wind, extending the "active" lifespan of their kite.

Drying

If a kite is packed away wet and left for a long period of time it can develop ugly mildew spots, rust on the metal parts or color bleeding of the cloth. This does not effect how the kite performs, but will reduce the value of your kite. In extreme cases the kite may get mouldy. To dry, simply continue to fly the kite until the canopy is dry.

Rinsing

Rinse your kite from time to time with clear water, after using it in salt water, and leave it to dry in the shade. Do not use any detergents. The warranty will be void after the use of detergents on the cloth.

Check

Check all parts of the kite before each use. Especially parts that can wear out. Material failure on those parts can lead to further damages, or put the kiter at risk.

12 ASSEMBLY OF THE B-SAFE SYSTEM

12.01 Conversion of the CONNECT² Control Bar from 4 lines Frontline Safety to 5 lines B-Safe System

The CONNECT² is delivered as a 4-line control bar with FLS (Frontline Safety System). Take the B-Safe line set out of the CONNECT² bar bag.



- 1 Unwind the flying lines until you reach the Front Connection Line.



- 2 Open the connection of the first Front Connection Line and the Front Line. Thread the Front Line slowly out.

Attention, thread all lines slowly to avoid damage caused by friction!

- 3 Connect the first Front Line with a double loop to the Front Connection Line.



The trim is necessary to ensure an equal total line length.

- 4 Thread the first Front Line slowly through the loop and tension both lines to ensure a tight connection.



- 5 Disconnect the Pigtail of the second Front Line and thread it slowly through the ring of the Front Connection Line.



- 6 Disconnect the second Front Line from the B-Safe Pigtail.



- 7 Connect the second Front Line with a Lark's Head below the ring of the Front Connection Line. Tension both lines to tighten the connection.



- 8 Connect the Front Pigtail of the second Front Line. Both Front Lines are now ready.

- 9 Unwind both 5,1 m B-Safe Lines from the cardboard winder. These lines are already connected and build one 10 m B-Safe Line. Connect the B-Safe Pigtail and the 10 m B-Safe Line with a double loop.



Note: Leave the connection part where the 5,1 m B-Safe Lines are connected to each other at the standard setting. The variable connection part can be used to extend the total length of the B-Safe line after heavy use.



- 10 Unwind the 7 m B-Safe Line from the cardboard winder. Connect the 7 m B-Safe Line with the end of the 10 m B-Safe Line.



Attention, all line connections must be tight!

- 11 Thread the B-Safe Lines with a total length of 17 m through the ring of the Front Connection Line.



Attention: the B-Safe Pigtail with the double loop knot should not slip through the ring!

The CONNECT² Control Bar is now B-Safe System ready and operates on 5 flying lines.

12.02 Instalment of the B-Safe Top Lines

- 1 Take the cardboard winder with B-Safe Top Lines out of the PEAK⁵ bag. Thread both B-Safe Top Lines slowly through the loop at the end of the B-Safe Line (5th line) of the CONNECT² Control Bar.



Note: A knot can be formed with the end of the B-Safe Line in order to connect the B-Safe Top Lines with a Lark's Head. This method is recommended if you want to fly several kites with one control bar.

- 2 Unfold the PEAK⁵ on the ground in front of you. Start in the middle of the PEAK and lift the A-Level on either side of the wing.

Tip: Go beneath the A-Level and lift it above your head. Put it on the shoulder which points toward the middle of the PEAK⁵.

- 3 The lines of the B-Safe System run through the rings integrated into the B-Level ribs. Search for the red LCL (Little Connection Line) and connect the B-Safe Top Line with a Lark's Head knot.



- ④ Check if the B-Safe Top Line is correctly attached and runs free beneath the A-Level. Repeat the process on the other side of the PEAK[®].



13 MAINTENANCE

The main parts that wear on the kites are the Depower Line, the Safety Endline (see the bar manual), as well as the Sparepart Lines and the pulleys. Depending on use, the flying lines and other parts will need to be replaced within the lifespan of your kite. If you do not service these parts, it can lead to damage to the kite and will void the warranty.

13.01 Replacing the Sparepart Lines and Pulleys

The Sparepart Lines are the yellow lines that run through the pulley system known as the mixer. The sparepart line should be replaced before the sleeving could tear or fray (approx. 100 h). The pulleys should be changed after about 250 hours of use.

Before exchanging your sparepart lines, perform a mixertest to note down your current mixertrim. When exchanging sparepart lines, this trim will change and you might want to keep your preferred trim, after the line exchange you can then adjust to your previous setting.

Tip: Always exchange only one side at a time and use the other side as a template how the mixer should look like.

- ① Lay out the kite and sort out the bridle. Make sure that the lines do not get crossed or mixed up through the whole procedure.

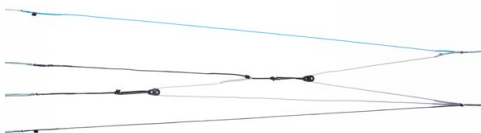

- ② Disconnect the front and steering lines on one side. Undo the front- and back main lines at the mixer.

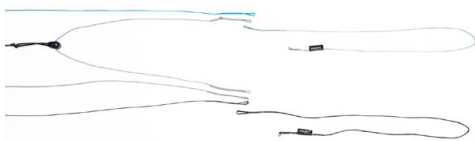

- ③ Pull the old sparepart lines out of the pulley. Always exchange both lines.

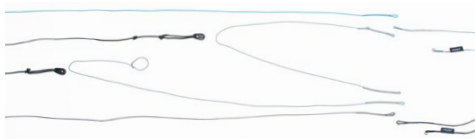

- ④ When exchanging a pulley (after 250h of use) concentration is needed. First make a larks head at the end of the line.



- ⑤ Put the pulley through the loop.



- ⑥ Pull the larks head knot tight.



- ⑦ Make sure to attach the new sparepart line in the same way as the old one.



8 The long sparepart line has a knot at the end, this knot is there to block the pulley from sliding over. Now pull the ring through the loop and attach to the flying line. Redo the front- and back main lines and pull the knots tight.

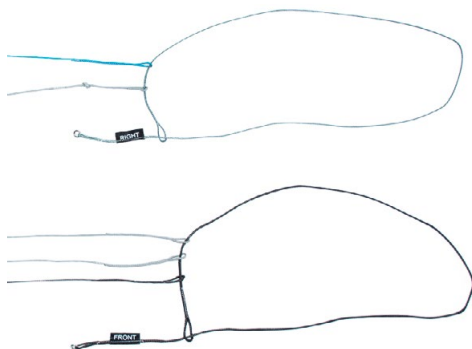

9 Reconnect the flying lines again, and then repeat the same procedure on the other side. Pull all knots tight and check the bridle carefully.

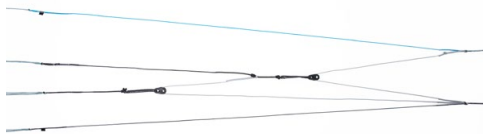

Warning: After exchanging the sparepart lines, do the bridle check and adjust the camber trim system accordingly.

13.02 Little Connection Lines

The "Little Connection Line" (LCL) allows you to quickly exchange a bridle line and also works as a predetermined overload weak point that prevents the canopy from getting damaged. Should an LCL break, replace it with new one, in the same colour (same breaking strength) LCL.



13.03 Repairing the Cloth

In case you get a small tear (e.g. through contact with a sharp object) we have included a repair kit with your kite. The area that needs to be repaired must be clean, dry and grease-free. Temporary repairs are possible with spinnaker repair tape, but the tear should be taped from the inside of the kite. It is recommended that you round off the edges of the repair tape. A special binding agent (silicone sealing compound) for the X-Light Cloth is available through Flysurfer sales partners or directly at FLYSURFER. A repair manual is included with the binding agent. There is the possibility to have a professional repair done by us. We can exchange whole parts of the canopy, so that there will be no trace of the damage.

Tip: When a tear is close to a seam (less than 5cm), we recommend using sewing to repair the damaged area.

14 TRIMMING

As all lines change length over time, we have built in a way to correct the flying characteristics quickly and easily. Adjustments after heavy use over years should be done to keep the products performance and ensure a long-term use of the PEAK.

14.01 Mixer

Bridle levels of the kite are controlled by the mixer, a pulley system which modulates the angle of attack and the profile camber. The mixer features the two-ring **camber trim system**.

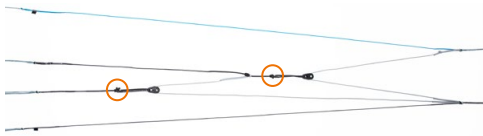

14.02 Camber Trim System

1 Sort out the mixer. Hold the loops next to the little flags in line and set A & Z on the same level.



- 2 Now tension the mixer and secure the ends of the front and steering lines (e.g. an assistant can hold them). The position of the lines should not change during the whole mixer test.



- 3 Bring the C-Level up to the A and Z bridle connection knots and tension the mixer (min. 5 kg tensile load per line). All three knots should be at the same level at standard trim.



- 4 If this is not the case, you just have to move the metal ring of the mixer (C-Level) until all 3 knots are at the same level.



Tip: The mixer is basically a 2:1 pulley system. If you want to change the B-Level by one centimeter, you will need to move the ring by two centimeters.

- 5 Bring the B-Level up to the A, C and Z bridle connection knots and tension the mixer. All four knots at the same level create a standard factory trim (+/- 0cm).



- 6 If this is not the case, you just have to move the metal ring of the mixer (B-Level) until all 4 knots are at the same level.



- 7 Done. Be sure to pull everything properly tight again after adjusting, so that the trim stays under tension.

Tip: When the mixer is set to the standard trim (+/- 0cm), e.g. all four knots are at the same level. It is enough to only move the metal ring of the mixer (C-Level) to change the basic trim. The B-Level automatically adjusts half the amount of the C-Level when modifying.

14.03 Optimum trim of the flying lines

Steering (back) lines shorten over time in relation to the flying (front) lines. Underneath the floaters, the back line can be shortened or extended by using knots. Extension of the back lines is necessary when the trimmer needs to be pulled in too much to keep the kite flying normally in its intended wind range. (back-stall tendency).

15 REPAIR & SPARE PARTS

Repairs can be done at either our workshop in the head office, or by a Flysurfer sales partner who offers a repair service. High quality original spare parts for all our Flysurfer products can be ordered directly from our Online-Shop: shop.flysurfer.com



FLYSURFER

FLYSURFER Kiteboarding
Brand of Skywalk GmbH & Co. KG
Windeckstr. 4
83250 Marquartstein, GERMANY